

FUNCTION

Monitoring differential gaseous pressure, non-aggressive media. Possible areas of applications are:

- air-conditioning and clean rooms;
- building automation;
- valve and flap control;
- fluid and level monitoring;
- control of air flows.

Transduction in voltage and current values.

Each transmitter can be set with two pressure ranges using the jumper "Range". The factory setting is for range 1 (jumper inserted). To choose range 2, remove the jumper.

The response time of output signal can be configured. The factory setting is for slow response 1 s (useful for suppressing pressure peaks), jumper "Response inserted". To increase fast response remove the jumper.

The output level of 3- wire models can be configured in 0...10 Vdc (factory setting, jumper "Output" inserted) or 4...20 mA by removing this jumper.

TECHNICAL DATA

Power supply:	see order selection table
Sensor:	piezoresistive pressure transducer
Measuring range:	see order selection table
Overload:	see order selection table
Rupture press.:	see order selection table
Accuracy:	< ± 0,2 % of end of scale
Typical long term stability:	< ± 0,5 % to ± 2,5 % of end of scale/year
Outputs / load:	0...10 Vdc (max 10 mA) 4...20 mA < 20...500 Ohm
Supply current:	max 30 mA for AC (0...10 Vdc), max 20 mA for DC (0...10 Vdc), max 30 mA (4...20 mA) for 2-, 3- wire

Working temp.:	0...+50 °C
Storage:	-10...+70 °C
Humidity:	0...95 % r.h., without condensing
Response time:	100 ms or 1 sec., selectable
Housing:	housing with process connection P2 made of ABS, mounting part with process connection P1 made of POM can be mounted in any position
Installation:	IP54 (with cover), class I
Protection:	EN60770, EN61326
Standards:	Ø 118 x h 57,5 mm
Max dimensions:	170 g
Weight:	

TYPE	RANGE 1	RANGE 2	OUTPUT SIGNAL	DISPLAY
RIB984M.323204	0...100 Pa (1.0 mbar)	0...250 Pa (2.5 mbar)	4...20 mA	No
RIB984M.343304	0...500 Pa (5.0 mbar)	0...1.000 Pa (10 mbar)	4...20 mA	No
RIB984M.343714	0...500 Pa (5.0 mbar)	0...1.000 Pa (10 mbar)	0...10 Vdc	Yes
RIB984M.353704	0...1 kPa (10 mbar)	0...2.5 kPa (25 mbar)	0...10 Vdc	No
RIB984M.353D04	0...1 kPa (10 mbar)	0...2.5 kPa (25 mbar)	4...20 mA	No

For other models see the list below:

RIB984M.3

X 3 X X 4

Pressure ranges (Pa):

Range 1	Range 2	overload max	
0...100 Pa (1.0 mbar)	0...250 Pa (2.5 mbar)	20 kPa	2
0...250 Pa (2.5 mbar)	0...500 Pa (5.0 mbar)	20 kPa	3
0...500 Pa (5.0 mbar)	0...1.000 Pa (10 mbar)	20 kPa	4
0...1 kPa (10 mbar)	0...2.5 kPa (25 mbar)	40 kPa	5
0...5 kPa (50 mbar)	0...10 kPa (100 mbar)	60 kPa	7
0...25kPa (250 mbar)	0...50 kPa (500 mbar)	300 kPa	9
0...100 kPa (1000 mbar)	0...250 kPa (2500 mbar)	1.2 MPa	B
-50Pa...+50Pa (-0,5mbar...+0,5mbar)			x
Pressure unit	Pascal		

Outputs and power supply

0...10 Vdc	24 Vac/dc, with open collector NPN output, 3- wire cable	1
4...20 mA	24 Vdc, without open collector NPN output, 2- wire cable	2
4...20 mA	24 Vac/dc, with open collector NPN output, 3- wire cable	3
0...10 Vdc	24 Vac/dc, without open collector NPN output, 3- wire cable	7
4...20 mA	24 Vac/dc, without open collector NPN output, 3- wire cable	D

Display

None	0
with LED-display, 3.5 digits (not for output 4...20 mA, 2 wires)	1

Electrical connections

Screw terminal block

Accessories on request

Connection set	DBZ-06
Mounting bracket	DBZ-14A
Mounting bracket	DBZ-14B
Test certificate	104552

WIRING DIAGRAM

RIB984M.3x31x4
RIB984M.3x37x4

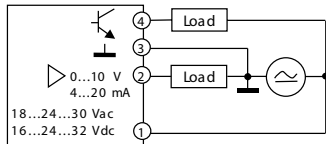

4	SA	Switching output, npn
3	GO	Ground GND
2	Y	Output signal 0 ... 10 V / 4 ... 20 mA
1	G	Supply voltage 24 VAC/ VDC

RIB984M.3x32x4

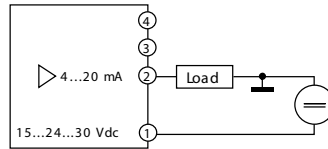

4		
3		
2	Y	Output signal 4 ... 20 mA
1	G	Supply voltage 24 VDC

RIB984M.3x33x4
RIB984M.3x3Dx4

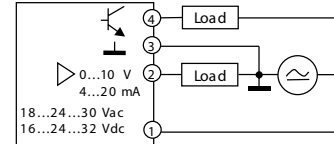

4	SA	Switching output, npn
3	GO	Ground GND
2	Y	Output signal 0 ... 10 V / 4 ... 20 mA
1	G	Supply voltage 24 VAC/ VDC

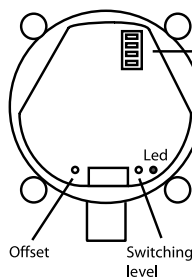

Range	Range 1	Range 2
Response	slow	fast
Mode	linear	square root
Output	0...10 V	4...20 mA

■ Jumper yes
▬ Jumper no

P1: positive pressure measurement
P2: depression measurement
P1 + P2: differential pressure measurement

* Only for 3-wire model without display and only on request.

VERSION WITHOUT DISPLAY

Setting of switching output:

Apply a differential pressure corresponding to the transistor commutation point required. Then press the key "Switching output" for 5 s until led flashes (= value is saved). The led lights when the pressure set is reached or exceeded.

Offset calibration:

In order to correct zero-point deviation of output signal in depressurized state (ex: to 0 Vdc/ 4 mA at 0 Pa), disconnect the unit from pressure by opening both hoses, then press the "Offset" button for 5 s.

VERSION WITH DISPLAY

Commutation point setting:

Press the key "M" two times, the message "SP" appears on display. Press the key "S" to visualize the current point of commutation. To change the point of commutation value press the key "S" for 5 seconds then press the key "M" to memorize it. Press the key "M" several times until the measured value appears on the display.

Offset calibration:

Press the key "M" two times, the message "OFFS" appears on display. Press the key "S" one time to see the current value of Offset. To change Offset value press the key "S" for 5 seconds then press the key "M" to memorize it. Press the key "M" several times until the measured value appears on display.



RIB984

DIFFERENTIAL PRESSURE TRANSMITTER

PRESSURE CONTROLS



DIMENSIONS (mm)

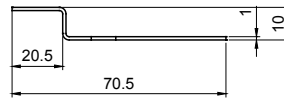
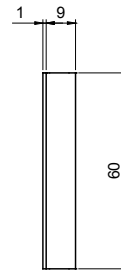
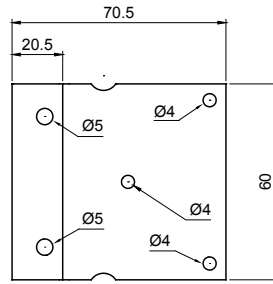
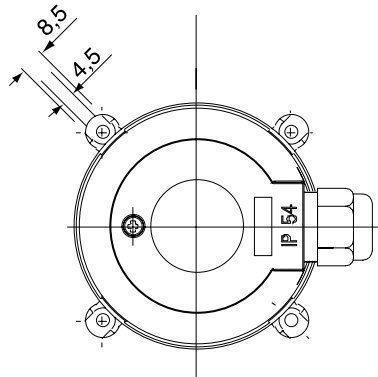
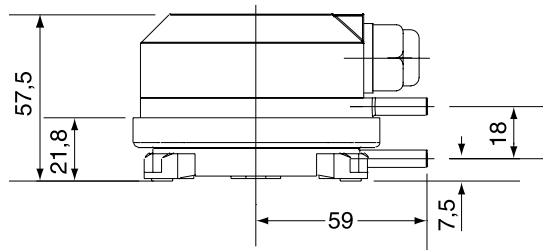
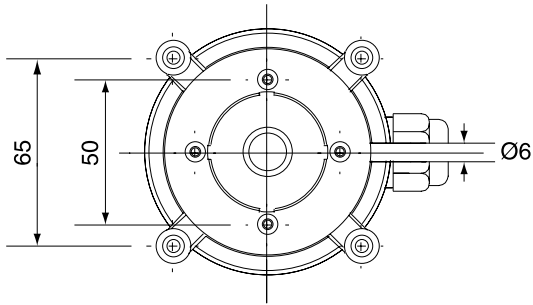

DBZ-14A

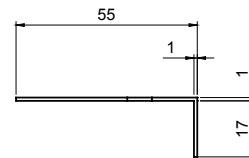
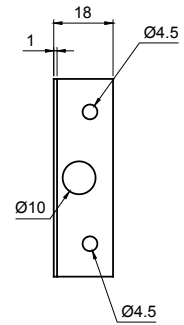
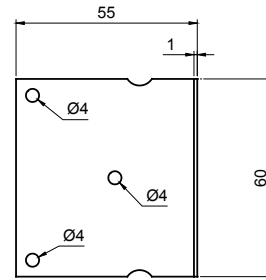
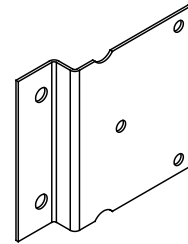

DBZ-14B

